

NuStep[®] T6

Recumbent Cross Trainer

USER MANUAL



Transforming Lives[®]

Contents

Introduction.....	4
Safety Instructions.....	5-6
Intended Purpose and Use.....	7
Installation and Placement.....	8
AC Adapter Use.....	9
T6 Feature Overview	10
T6 StrideLock®	11
Making Adjustments.....	12-14
Correct Riding Position	14
Display Screens.....	15-16
Pause Function	17
System Settings.....	18-19
User Settings.....	20
Exporting User Profile Data	21
Exporting Workout Summary	22
Preventive Maintenance.....	23
Warranty and Serial Number Information	24
Obtaining Customer Service and Parts	25
Technical Data.....	26
Safety Notifications.....	27-28
EMC Tables	29-32
US FCC Compliance & IEC/EN 55011 Compliance.....	33

Introduction



Thank you for purchasing the NuStep T6 Recumbent Cross Trainer.

As the originator of the recumbent cross trainer, NuStep is the leader in developing seated total-body exercise systems that are inclusive, effective and easy-to-use. Our products are used in healthcare settings, wellness centers, and senior living communities worldwide.

The T6 marks a milestone in NuStep's continuous pursuit of advancement, customer satisfaction and best-in-class quality. As a customer-focused company, NuStep turned to our customers, including healthcare professionals, and fitness experts for insight on what features to include in the product. The T6 is the end-result of this valuable feedback.

Thank you for your business and welcome to our ever-expanding network of NuStep users.

Safety Instructions

	 CAUTION	 WARNING
<p>This is the safety alert symbol. It is used to call attention to instructions concerning personal safety. Read and obey all safety messages that follow this symbol to avoid possible injury or death resulting from misuse.</p>	<p>CAUTION indicates a potentially hazardous situation, which if not avoided, may result in minor or moderate injury. It may also be used to alert against unsafe practices.</p>	<p>WARNING indicates a potentially hazardous situation, which, if not avoided, could result in death or serious injury.</p>

 WARNING
<p>Do not modify this equipment without authorization of the manufacturer.</p> <p>Use this equipment only for its intended use as described in this manual.</p> <p>Do not use attachments not recommended by the manufacturer.</p> <p>Never operate this equipment if it has a damaged cord or plug.</p> <p>Keep cord away from heated surfaces.</p> <p>Never drop or insert any object into any opening.</p> <p>Do not use outdoors.</p> <p>Injuries to health may result from incorrect or excessive training.</p> <p>Heart rate monitoring systems may be inaccurate. Over exercising may result in serious injury or death. If you feel faint stop exercising immediately.</p>

Safety Instructions



CAUTION

See your physician before beginning any exercise program.

Supervision is required if you have a disability or medical condition.

Stop exercising if you feel faint or dizzy while using this product, and seek medical help or advice.

Use this product only as directed by your physician if you have any type of heart disease, hypertension, diabetes, respiratory disease, or any other medical problem, or if you are pregnant.

This product may be used by persons with reduced physical, sensory, or mental capabilities, or lack of experience and knowledge if they are supervised by a person responsible for their safety.

Read this manual before using this product and save it for future reference.

Always wear shoes and proper clothing when exercising.

Do not touch or hold product with non-intact skin.

Do not operate this product if it appears damaged or inoperable. Examine product regularly for damage and wear. Ensure defective components are replaced immediately.

Do not perform maintenance or repairs on this product while it is in use.

Make sure the seat position and



CAUTION

upper arm position are correctly setup for you. Do not over-extend your legs or your arm reach.

Do not let children use this product.

Do not use this product in the presence of children and/or pets.

Keep children under the age of 13 away from this machine.

The heart rate, watts, METs and calories displays are not suitable for use in applications where the health and safety of the patient may be dependent on the accuracy of those parameters.

The maximum user weight capacity:
T6PRO model = 500 lbs (227 kg)
T6MAX model = 600 lbs (272 kg)

Do not lift this product by yourself. The T6 is very heavy; it weighs 298 lbs (135 kg).

To avoid injury, or damage to the product, always obtain assistance to move this product. Use proper lifting techniques.

To avoid injury, do not insert hands in any cover openings.

To ensure safe operation of this product, place on a flat stable surface. Adjust leveler feet as required.

This product is intended to be connected to AC mains power through the furnished AC adapter only.

SAVE THESE INSTRUCTIONS.

Intended Purpose and Use

Intended Purpose

The NuStep® recumbent cross trainer is an apparatus for therapeutic exercise.

Intended Use

The recumbent cross trainer may be used to improve aerobic fitness, strength and endurance. The recumbent cross trainer includes the following features and functionality to assist individuals who are mobility impaired:

- Swivel seat;
- Arm rests;
- StrideLock®;
- Stabilization straps;
- Contralateral exercise motion.

Under the guidance and supervision of a physician and/or a physical therapist, the recumbent cross trainer may be used by cardiac, cardiovascular, and physical therapy patients for therapeutic exercise. The physician and/or physical therapist responsible for the patient's care shall assess the benefits and risks of using the recumbent cross trainer for therapeutic exercise prior to each use to ensure that the chosen form of use is appropriate and reasonable.

Intended Operator

The intended operators are qualified healthcare professionals who have been trained on the information provided in the recumbent cross trainer user manual. The patient or exerciser is not the intended operator, but the intended operator may allow the patient or exerciser to operate the recumbent cross trainer according the instructions in the product user manual. The operation of the recumbent cross trainer remains the responsibility of the intended operator at all times.

Intended Location

The recumbent cross trainer is suitable for use in the following facilities:

- Physical therapy clinics;
- Cardiopulmonary rehabilitation clinics;
- Sports medicine clinics;
- General wellness centers.

Installation and Placement

Unpacking and Installation

Unpacking and installation procedures for T6 shipments are documented in the applicable T6 delivery installation guideline documents. The installation guideline documents are shipped with the products. Additional copies of these documents are available upon request from Customer Service.

CAUTION

The T6 is very heavy; it weighs 298 lbs (135 kg).

To avoid injury, or damage to the product, always obtain assistance to move this product.

Use proper lifting technique.

Placement of Equipment

To ensure safe and effective operation of your NuStep, place on a flat, stable surface. Adjust rear leveler feet as required.

The minimum amount of required free space around the equipment is 24 inches (61 cm) for the sides, and 12 inches (30 cm) for the front and rear. Additional free space is necessary to accommodate wheelchair access.

For added stability and floor protection, place the recumbent cross trainer on an exercise equipment floor mat similar to the floor mat sold by NuStep, LLC.

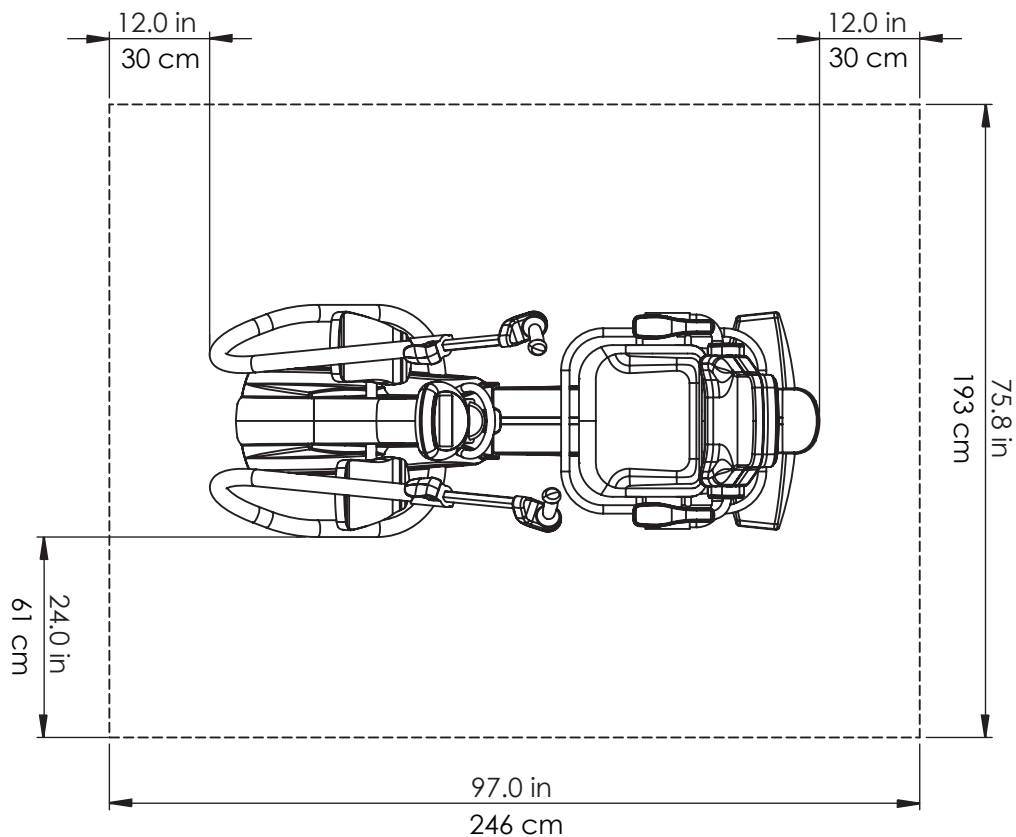

AC Adapter Use

The T6 is powered by an AC adapter which is included with the equipment. The AC adapter may be plugged into either the front or the rear jack.* Plug the adapter into an appropriate power outlet.

Route the AC adapter power cable in a manner that prevents tripping hazards and prevents damage to the adapter. Avoid placing any pressure or strain on adapter cables, jacks or plugs.

For adapter specifications, please refer to the Technical Data section of this manual.

**Do not connect the T6 to two AC adapters simultaneously.*

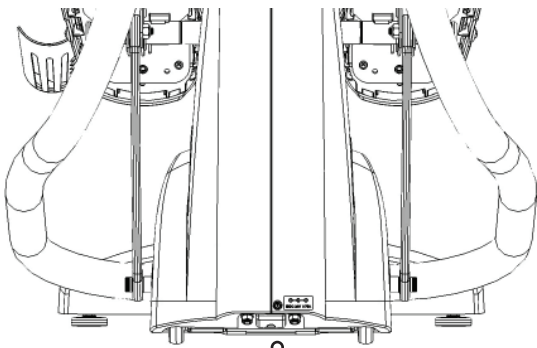
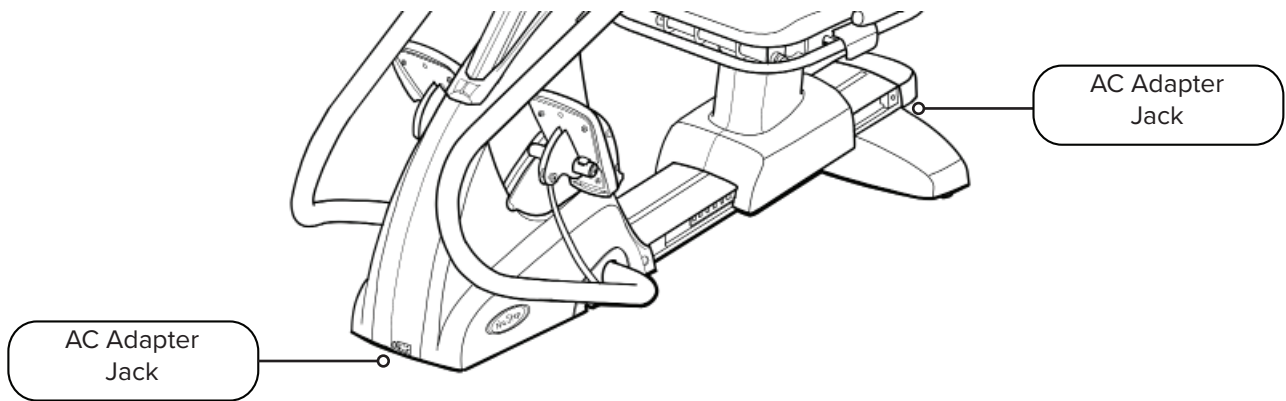

Front Jack

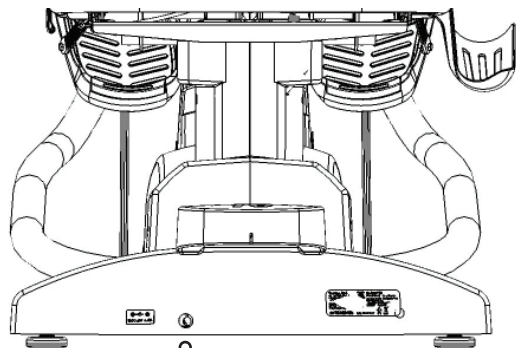

Rear Jack

T6 Feature Overview

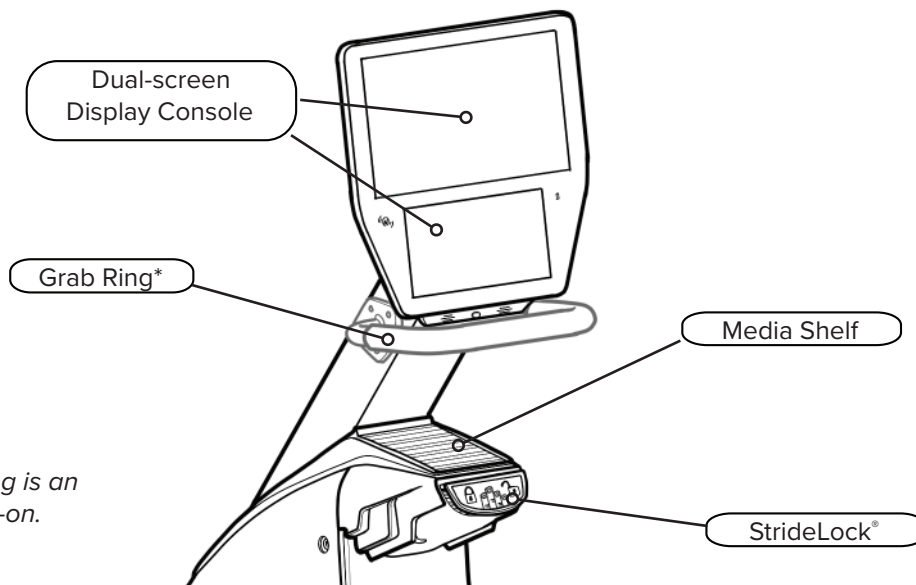
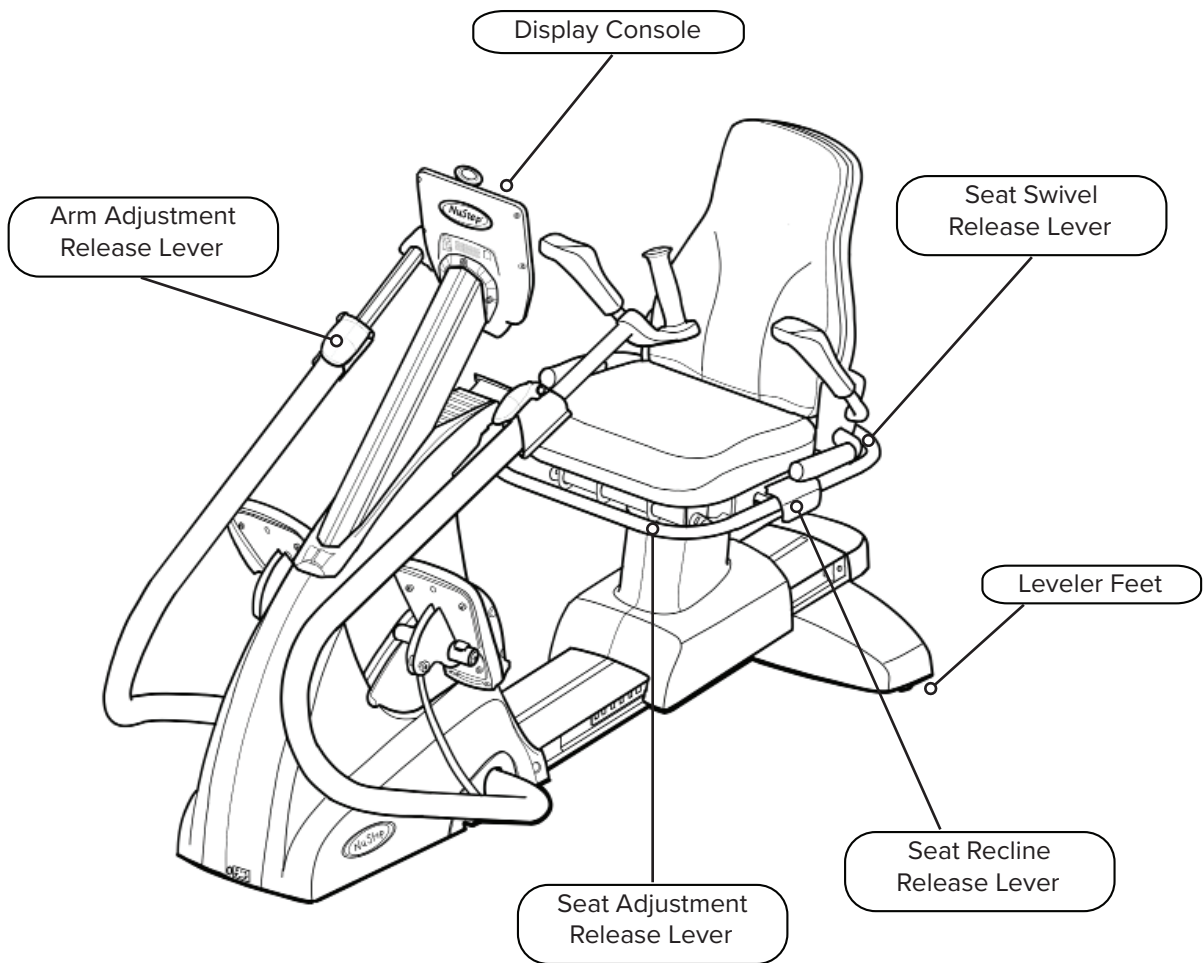

**The grab ring is an optional add-on.*

T6 StrideLock®

The StrideLock feature allows users to lock the arm handles and foot pedals on the T6. When StrideLock is engaged, the handles and pedals do not move. This stabilizes the product and makes it easier for the user to:

- Get on and off the T6
- Adjust seat and handle positions
- Fasten footstraps or attach adaptive accessories



StrideLock lever

To engage StrideLock:

1. Use the arm handles to push or pull the arms and pedals to the desired position.
2. Push down on the yellow StrideLock lever and release. The lever will be in an **UP** position when **locked**.
3. Check the StrideLock is engaged by pushing or pulling on the arm handles – they should not move.



Lever is up when handles and pedals are locked.

To disengage StrideLock:

1. Push down on the StrideLock lever again. The lever will be in the **DOWN** position when **unlocked**.



Lever is down when handles and pedals are unlocked.

Making Adjustments

Adjust Seat Distance

1. Lift the front yellow lever to unlock.
2. Using feet, slide seat forward or backward to adjust distance.
3. Check that knee has a slight bend when leg is nearly fully extended.
4. Release lever to lock seat in place.



Lift front lever to adjust seat distance.



Knee has slight bend when leg is nearly fully extended.

Adjust Seat Recline

1. Place feet on pedals.
2. Lift the black lever on left side to unlock.
3. Push on seat back to increase recline (up to 12° recline possible).
4. Release lever to lock seat in place.



Lift black lever on left side.



Push on seat back to adjust recline angle.

Making Adjustments

Adjust Handle Length

1. Pull up on the yellow arm adjustment release lever to unlock arm handles.
2. Slide handle in or out to adjust length.
3. Adjust handles until elbow is slightly bent when arm is almost fully extended (for many people this may be the same number as their seat position).
4. Press release lever down to lock into position.



Pull up on lever to unlock.



Push down on lever to lock.

Adjust Arm Rotation

1. Pull up on the yellow arm adjustment release lever to unlock.
2. Rotate the hand grip right or left.
3. Once set, press the release lever down to lock in position.

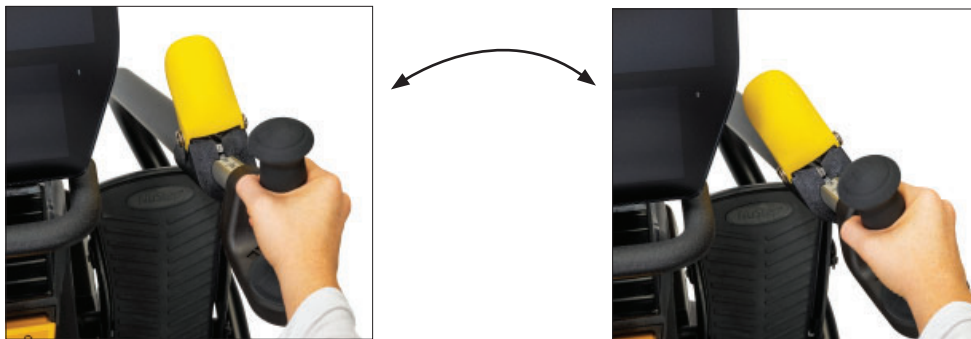

Making Adjustments

Swivel Seat Operation

1. Lift the rear release lever to unlock seat.
2. Swivel the seat in either direction (seat swivels 360° and locks every 45°).
3. Release the lever to lock seat in position.

NOTE: The seat can be rotated with or without a user on the machine. For safety, the seat distance cannot be adjusted unless it is facing forward.



Lift rear lever to unlock seat.



Seat swivels 360° in either direction and locks in place every 45°.

Correct Riding Position

After adjusting the arm handles and seat position on the T6, there should be a *slight* bend in your knees and elbows at nearly full extension when exercising on your T6.

	CAUTION
Injuries to health may result from incorrect or excessive use.	
Ensure the seat and arms are set up in biomechanically correct positions.	
Do not over-extend your leg or arm reach distance.	

Elbow has slight bend when arm is nearly fully extended.



Knee has slight bend when leg is nearly fully extended.

Display Screens

The T6 has a Home screen and Metric screen with touchscreen navigation:

Home screen: Displays workout apps *Quick Start*, *Pace Partner* and *NuStep Charts*. Tap app icon to launch.

Metric screen: Displays all workout metrics including *time*, *speed (steps per minute)*, *total distance*, *watts*, *calories*, *METs*, *resistance level* and *heartrate*.



App Screens

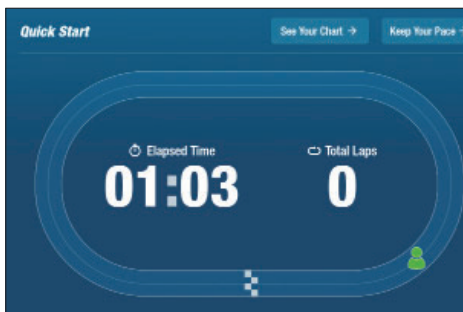

Quick Start

Users can work out without setting pace goals or selecting metric values. Users can switch to other apps from the *Quick Start* screen. To switch:

- Tap **See Your Chart** to open the *Performance Charts* app
- Tap **Keep Your Pace** to open the *Pace Partner* app

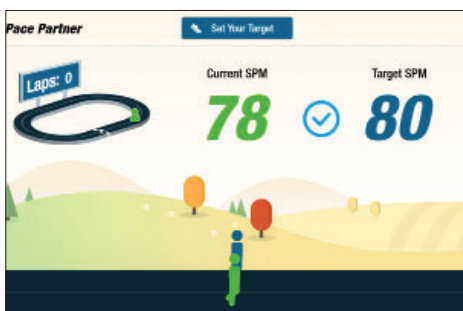

Pace Partner

Users set a target pace and workout metric *SPM*, *Watts* or *METs*. Goal is to keep current pace at the target pace. To set goals:

- Tap **Set Your Target** to open *Your Target Pace* screen

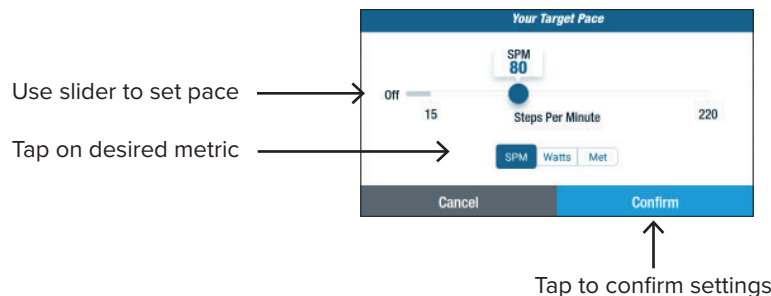

Display Screens



Performance Chart

Displays performance metrics - *Pace (SPM)*, *Watts*, *Load* or *METS* over time. To toggle between charts, tap on desired metric tab.

Metric screen

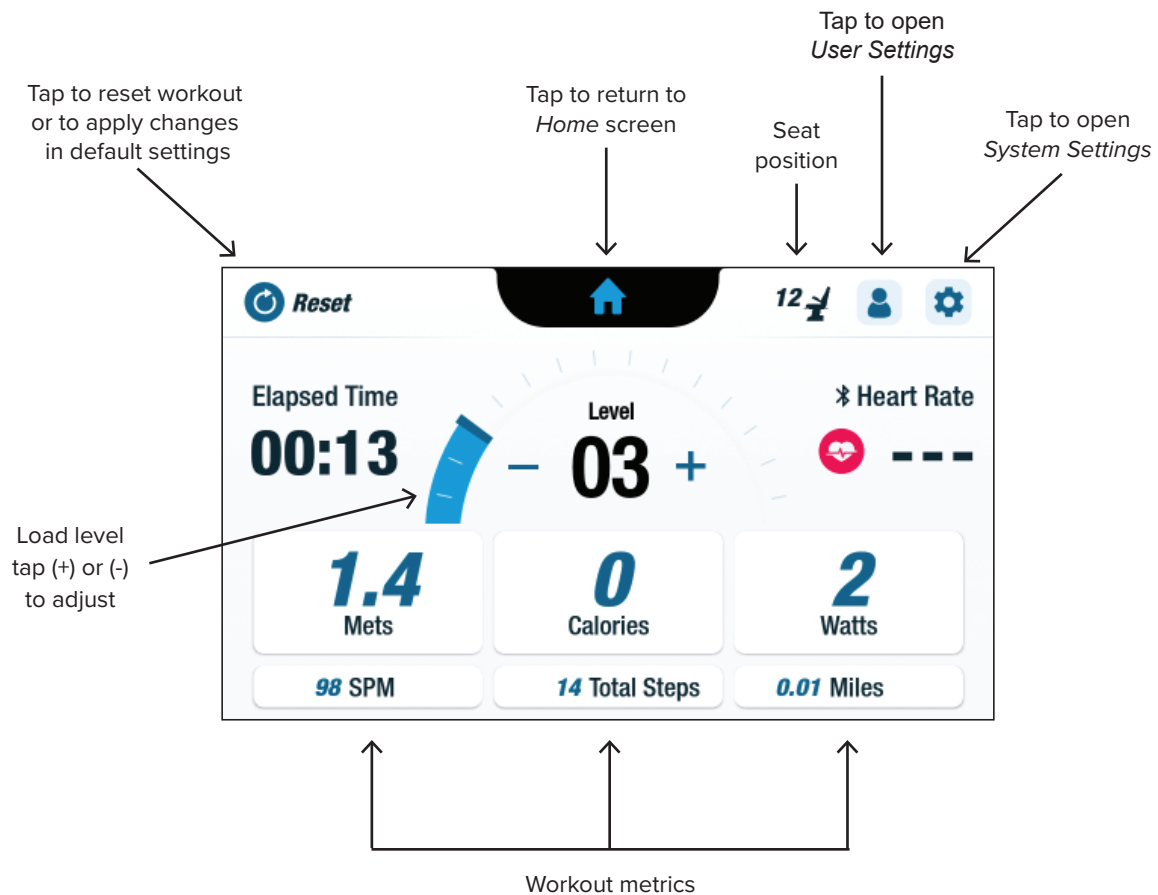

Pause Function

The T6 has a 3-minute console shutdown. If a user stops stepping and does not resume stepping within three minutes, the console will reset.

Before the console shuts down, the user has the option to extend the pause (e.g., for interval training) for an additional 15 minutes.

To extend the pause, tap *Extend Pause Time*.

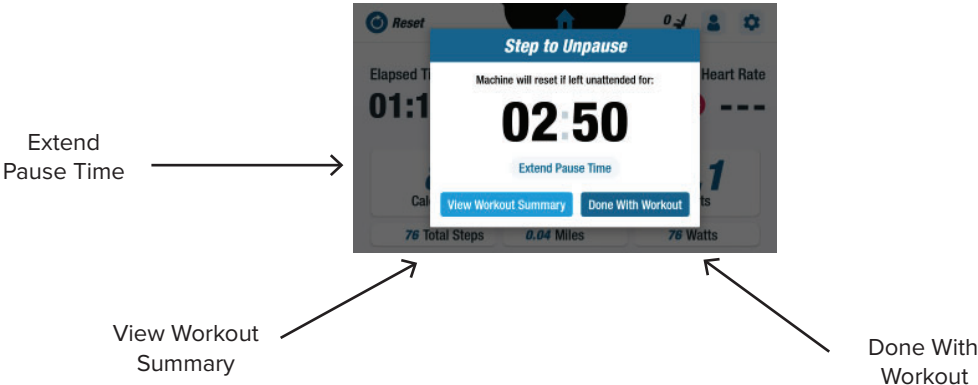

To see workout summary, tap *View Workout Summary*.



To end the session, tap *Done With Workout*.



System Settings

System Settings

Use to adjust volume and screen brightness, change default settings, view diagnostics, change metric configuration, view regulatory and software information.

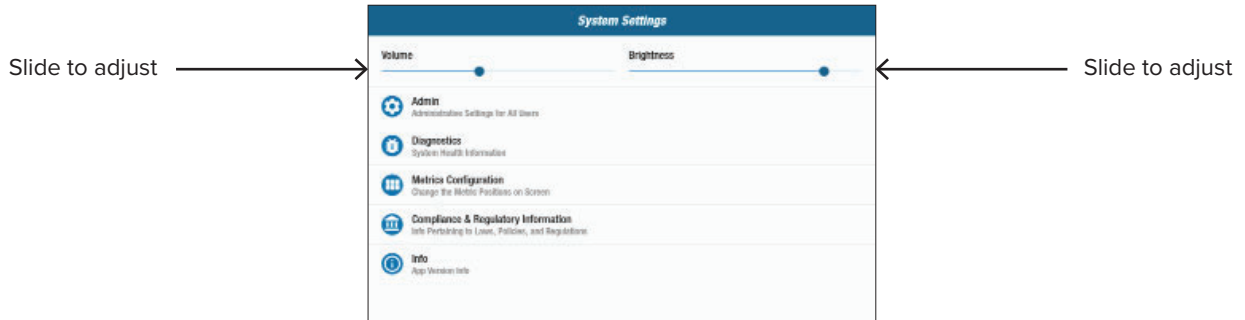

Admin

Use to change default settings (age, weight, gender). Changes made to the default settings are global. Once the Admin screen opens, a password is required to change default settings. To enter password:

1. Tap screen to open numeric keyboard.
2. Enter password, tap *Submit*.
3. Tap icon to close keyboard.

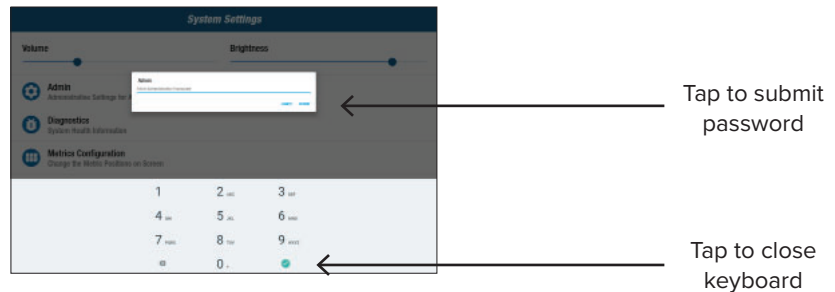

In the Admin screen:

1. Tap into default fields and enter new default settings.
2. Tap *Submit* to apply changes.

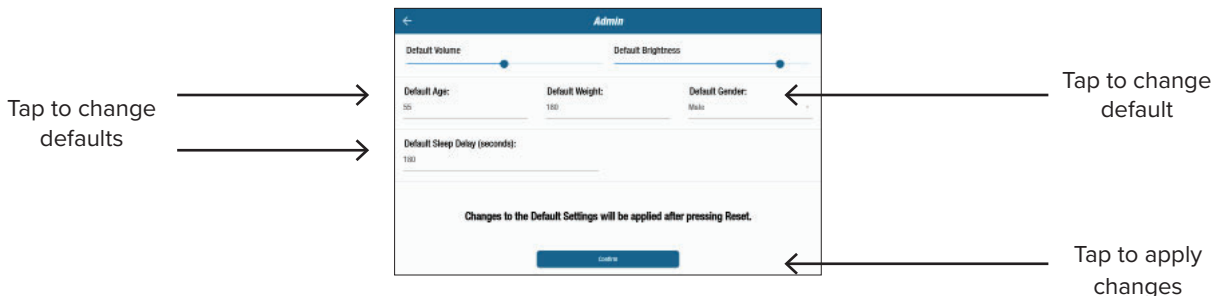

System Settings

3. Go to the *Metric* screen.
4. Tap  *Reset* to open the *Reset Workout* screen.
5. Tap *Reset* to apply changes.

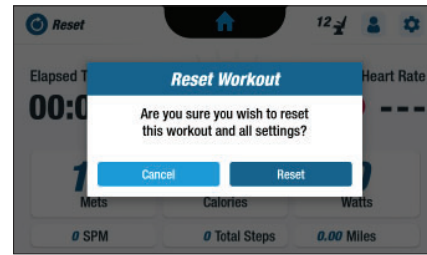

Diagnostics

The diagnostics screens display live and historical data for service technicians or those responsible for equipment maintenance. The *Historical and Versioning* screen requires a password to access.



Metrics Configuration

Users may change which metric units are displayed on the metric screen. The top row displays the current metric configuration. To change:

1. Tap on a current metric unit to highlight.
2. Tap on a metric unit for the highlighted slot.
3. Tap *Confirm* to apply change.

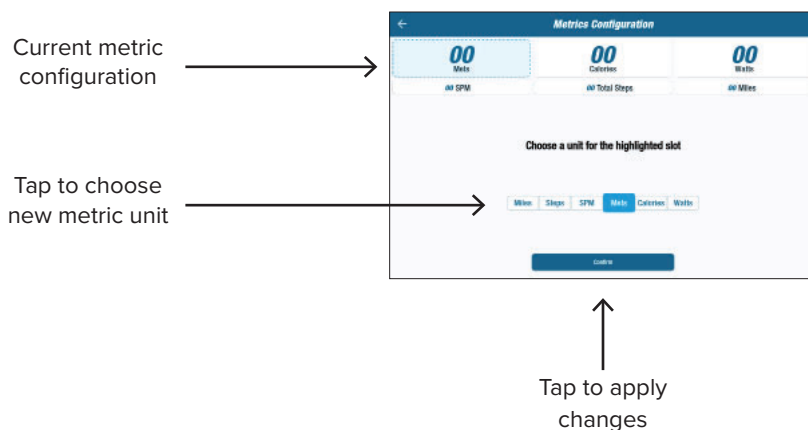

User Settings

User Configuration

Users can create and save a profile with their own settings. To change:

1. Tap screen to open numeric keyboard.
2. Enter age, weight and select sex.

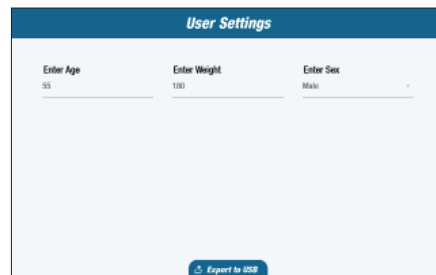

The screenshot shows a mobile application screen titled "User Settings". The screen has a light blue background and a dark blue header bar with the title "User Settings". Below the header, there are three input fields arranged horizontally. The first field is labeled "Enter Age" and contains the number "55". The second field is labeled "Enter Weight" and contains the number "180". The third field is labeled "Enter Sex" and contains the text "Male". Below these fields, there is a large, empty light blue area. At the bottom center of the screen, there is a dark blue button with the text "Export to PDF".

Exporting User Profile Data

Users can export their profile data to a USB drive at any time.

To export:

1. Insert USB drive into the USB port on the back of the display console.
2. Tap  on the *Metric* screen to open the *User Settings* screen.
NOTE: Skip this step if the profile screen launches automatically.
3. Tap *Export to USB* tab at the bottom of the screen.

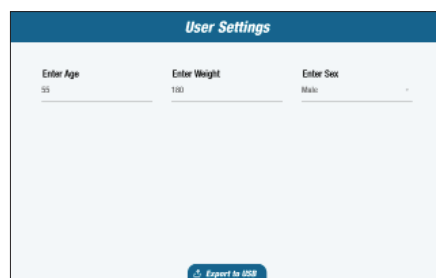
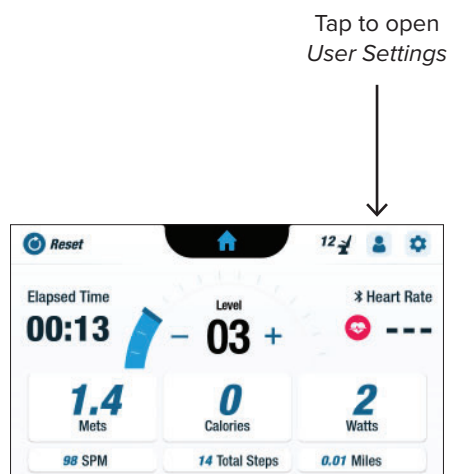

Tap to export profile data

Exporting Workout Summary

Users can export their workout summary to a USB drive. The summary is saved in a PDF format.

NOTE: Before working out, insert USB drive into the USB port on the back of the console.

At the end of a workout (when the user has stopped stepping) the *Step to Unpause* screen will open.

1. Tap *View Workout Summary*.

NOTE: Do not tap Done With Workout as this ends the exercise session and resets the machine. It does not allow the user to export their workout summary.

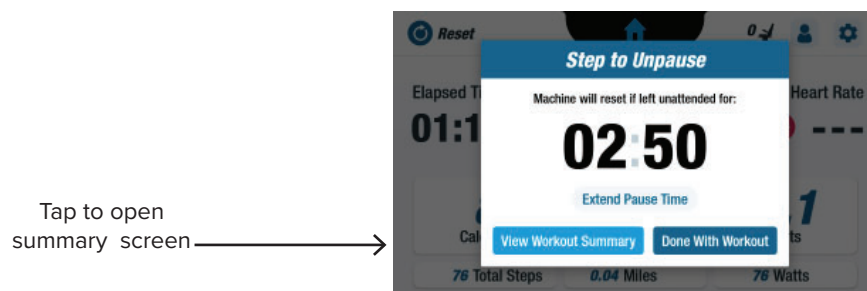

2. From the *Workout Summary* screen, tap *Export to USB*

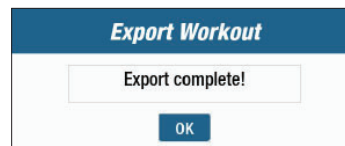
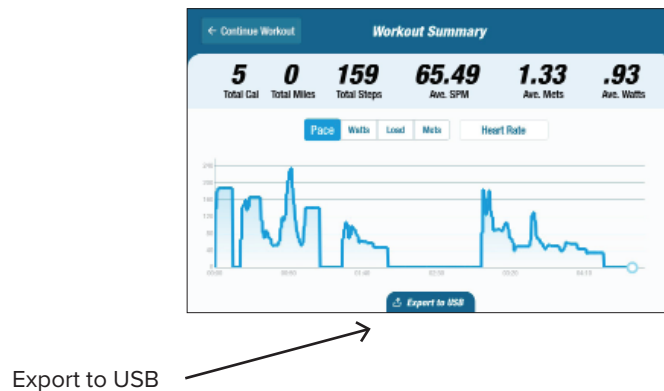

Preventive Maintenance

Preventive Maintenance Intervals

Although your T6 is designed to be maintenance free, we recommend a few tasks to increase the useful life of your equipment. Please follow the recommended preventive maintenance intervals shown below. These are estimated intervals and you may need to increase or decrease the frequency of preventive maintenance depending on your actual use.

ITEM	TASK	FREQUENCY
Arms, Handles and Grips	* Clean	Weekly
Console	* Clean	Weekly
Covers and Frame	* Clean	Weekly
Seat	* Clean	Weekly
* Use a non-abrasive spray cleaner and a soft cloth to clean the NuStep.		

Clinical Settings Note

In clinical settings, patients may operate this equipment in accordance with this user manual and the instructions and guidance provided by the healthcare personnel responsible for supervising their treatment and care. However, patients shall not perform preventive maintenance, repairs or replace batteries on equipment installed in clinical facilities.

T6 Warranty

To view your warranty online, go to: NUSTEP.COM

If you have any questions about your warranty, please contact Customer Service at: 800-322-4434 or support@nustep.com.

For customers outside of the US and Canada, please contact your local NuStep distributor for warranty details.

T6 Serial Number Information

Location on the product:

The serial number is located on the right side of the rear support cover.

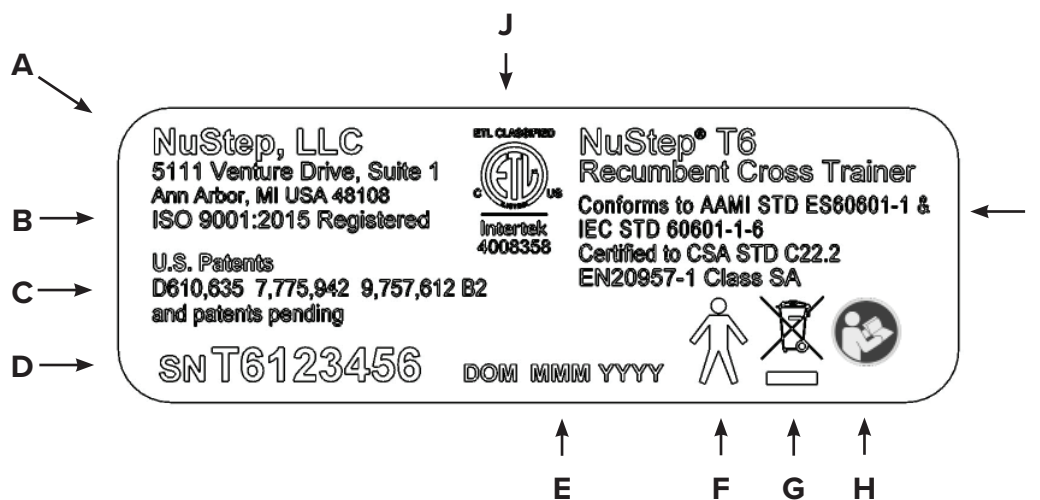

A	Manufacturer's name and address
B	Quality management system registered to ISO standard
C	Patent protection for the product
D	Model and Serial number
E	Date of Manufacture
F	Type B applied part for electrical safety
G	WEEE Directive Mark
H	Read the user manual before use
I	Compliance with standards
J	Nationally Recognized Test Lab Mark

Obtaining Customer Service and Parts

STEP 1 - Identify the problem.

If you did not experience the problem, speak with the person who did to get a clear understanding of the nature of the problem.

STEP 2 - Verify the problem.

Inspect the cross trainer. Determine which part(s) may be required to correct the problem. Figures and parts lists are available on the NuStep web site at: nustep.com or by contacting Customer Service.

STEP 3 - Contact NuStep Customer Service.

So that our product specialists can better assist you, please have a complete description of the problem and the serial number of the unit (see preceding page for location of serial number on the T6).

NuStep product specialists can be reached via e-mail or phone at:

Email: support@nustep.com



Phone: 800-322-4434 (US)
734-769-4400

Address: NuStep, LLC
5111 Venture Drive
Suite 1
Ann Arbor, MI 48108 USA



Web: NUSTEP.COM

For customers outside of the US and Canada that require customer service, please contact your local NuStep distributor.

Technical Data

USB A Port	USB port is for flash drive use only. Some flash drives may not be compatible with the T6 USB port. Do not connect external devices to this port with USB cables.
USB C Port	Connection for service only.
Ethernet Port	Connection for local network only. Do not connect the T6 to internet. Use port to connect to IEC 60601-1 compliant equipment only. Use IEC 60601-1 compliant in-line network isolator when connecting to non-medical equipment.
3.5 mm Audio Jack	Connection for passive earphones and headphones with 3.5 mm male jack only.
Standards	ANSI/AAMI ES60601-1, CAN/CSA-C22.2 No. 60601-1, IEC/EN 60601-1, IEC/EN 60601-1-2
Marks	
Eddy current resistance system	The T6 features a speed dependent eddy current resistance system that is dependent on workload level selected, the user step rate and the user step length. Range: 0 - 1400 watts
Stepping Action	The T6 features dependent stepping action with up to 8.5" (22 cm) stepping range.
Watts Testing Parameters	Displayed watt values represent the energy consumption rate of the user. They are calculated in real-time utilizing an algorithm based on mechanical parameters of the machine and a measured average ride style. The significant mechanical parameters that influence the displayed watt values include the inertia of the machine's moving components, the load level selected by the user, and the rotational velocity of the eddy current disk. Validation testing of the displayed watt values was performed by comparing said value and the actual measured mechanical power produced by multiple users. Displayed watt values are independent of any physiological or anatomical parameter possessed by the user.
AC Adapter	<p>Model AUTECH POWER SYSTEMS DT-M090-240-U-NSP or Model GlobTek TR9KI3750CCP-IM(R6B)</p> <p>Output 24V dc @ 3.75A 90W Max. Input 100-240V~50-60Hz, 1.5A</p> <p>The T6 must only be supplied at safety extra low voltage corresponding to the marking on the product.</p> 

Safety Notifications

TYPE / DEGREE OF PROTECTION	CLASSIFICATION / IDENTIFICATION/ WARNINGS	SYMBOL
Type of protection against electric shock	Class II equipment	
The degree of protection against electric shock	Type B applied part	
The degree of protection against the ingress of liquids	Not protected	N/A
The degree of safety in the presence of a flammable anesthetic mixture with air or with oxygen or nitrous oxide	Not suitable	N/A
The mode of operation	Continuous	N/A
Information regarding potential electromagnetic or other interference and advice regarding avoidance	The NuStep T6 Recumbent Cross Trainer uses electromagnetic and RF energy only for its internal function. Therefore, its EMC and RF emissions are very low and are not likely to cause any interference in nearby electronic equipment.	N/A
EMC warnings and tables required by IEC 60601-1-2	See EMC tables.	N/A

Safety Notifications

TYPE / DEGREE OF PROTECTION	CLASSIFICATION / IDENTIFICATION / WARNINGS	SYMBOL
<p>ID of any risks associated with the disposal of waste products, residues, including disposal of the equipment itself at the end of its useful life.</p>	<p>The NuStep T6 Recumbent Cross Trainer equipment contains electronic circuit assemblies and a coin cell battery that may require compliance with specific local disposal or recycling procedures.</p>	
<p>The specification of the environmental conditions of transport and storage (also marked on the outside of the packaging).</p>	<p>The NuStep T6 Recumbent Cross Trainer equipment can be:</p> <p>a) safely transported and stored in these conditions -10° to 50°C; ≤ 95% non-condensing humidity; 20 to 107 kPa</p> <p>b) operated in these conditions 5° to 40°C; ≤ 85% non-condensing humidity; 60 to 107 kPa.</p>	<p>N/A</p>
<p>Indication that the equipment is energized.</p>	<p>When the T6 is plugged in and not in use, the stand-by power indicator on the front of the console remains on.</p>	<p>N/A</p>

EMC Tables

Guidance and manufacturer's declaration – electromagnetic emissions		
The NuStep model T6 is intended for use in the electromagnetic environment specified below. The customer or the user of the NuStep model T6 should assure that it is used in such an environment.		
Emissions test	Compliance	Electromagnetic environment – guidance
RF emissions CISPR 11	Group 1	The NuStep model T6 uses RF energy only for its internal function. Therefore, its RF emissions are very low and are not likely to cause any interference in nearby electronic equipment.
RF emissions CISPR 11	Class B	The NuStep model T6 is suitable for use in all establishments.
Harmonic emissions IEC 61000-3-2	Not applicable	
Voltage fluctuations/ flicker emissions IEC 61000-3-3	Not applicable	

EMC Tables

Table 2 – Guidance and MANUFACTURER’S declaration – electromagnetic IMMUNITY – for all ME EQUIPMENT and ME SYSTEMS

Guidance and manufacturer’s declaration – electromagnetic immunity			
The NuStep model T6 is intended for use in the electromagnetic environment specified below. The customer or the user of the NuStep model T6 should assure that it is used in such an environment.			
Immunity test	IEC 60601 Test level	Compliance level	Electromagnetic environment – guidance
Electrostatic discharge (ESD) IEC 61000-4-2	± 6 kV contact ± 8 kV air	± 6 kV contact ± 8 kV air	Floors should be wood, concrete or ceramic tile. If floors are covered with synthetic material, the relative humidity should be at least 30%.
Electrical fast transient/burst IEC 61000-4-4	± 2kV for power supply lines	± 2kV for power supply lines	Mains power quality should be that of a typical commercial or hospital environment.
Surge IEC 61000-4-5	± 1 kV differential mode ± 1 kV common mode	± 1 kV differential mode ± 2 kV common mode	Mains power quality should be that of a typical commercial or hospital environment.
Voltage dips, short interruptions and voltage variations on power supply input line IEC 61000-4-11	<5% U_T (>95% dip in U_T) for 0,5 cycles 40% U_T (60% dip in U_T) for 5 cycles 70% U_T (30% dip in U_T) for 25 cycles <5% U_T (>95% dip U_T) for 5 sec	<5% U_T (>95% dip in U_T) for 0,5 cycles 40% U_T (60% dip in U_T) for 5 cycles 70% U_T (30% dip in U_T) for 25 cycles <5% U_T (>95% dip U_T) for 5 sec	Mains power quality should be that of a typical commercial or hospital environment. If the user of the NuStep® T5 Recumbent Cross Trainer requires continued operation during power mains interruptions, the NuStep® T5 Recumbent Cross Trainer would be powered from its internal batteries.
Power frequency (50/60 Hz) Magnetic field IEC 61000-4-8	3 A/m	3 A/m	Power frequency magnetic fields should be at levels characteristic of a typical location in a typical commercial or hospital environment.
NOTE U_T is the a.c. mains voltage prior to application of the test level.			

EMC Tables

Table 3 – Guidance and MANUFACTURER’S declaration – electromagnetic IMMUNITY – for ME EQUIPMENT and ME SYSTEMS that are not LIFE-SUPPORTING

Guidance and manufacturer’s declaration – electromagnetic immunity			
The NuStep model T6 is intended for use in the electromagnetic environment specified below. The customer or the user of the NuStep model T6 should assure that it is used in such an environment.			
IMMUNITY test	IEC 60601 TEST LEVEL	Compliance level	Electromagnetic environment – guidance
Conducted RF IEC 61000-4-6 Radiated RF IEC 61000-4-3	3 Vrms 150 kHz to 80 MHz 3 V/m 80 MHz to 2,5 GHz	3 Vrms 3 V/m	Portable and mobile RF communications equipment should be used no closer to any part of the NuStep model T6, including cables, than the recommended separation distance calculated from the equation applicable to the frequency of the transmitter. Recommended separation distance Not applicable $d = 1.2 \sqrt{P}$ 80 MHz to 800 MHz $d = 2.3 \sqrt{P}$ 800 MHz to 2,5 GHz Where P is the maximum output power rating of the transmitter in watts (W) according to the transmitter manufacturer and d is the recommended separation distance in meters (m). Field strengths from fixed RF transmitters, as determined by an electromagnetic site survey, ^a should be less than the compliance level in each frequency range. ^b Interference may occur in the vicinity of equipment marked with the following symbol: 
NOTE 1 At 80 MHz and 800 MHz, the higher frequency range applies. NOTE 2 These guidelines may not apply in all situations. Electromagnetic propagation is affected by absorption and reflection from structures, objects and people.			
a. Field strengths from fixed transmitters, such as base stations for radio (cellular/cordless) telephones and land mobile radios, amateur radio, AM and FM radio broadcast and TV broadcast cannot be predicted theoretically with accuracy. To assess the electromagnetic environment due to fixed RF transmitters, an electromagnetic site survey should be considered. If the measured field strength in the location in which the NuStep model T6 is used exceeds the applicable RF compliance level above, the NuStep model T6 should be observed to verify normal operation. If abnormal performance is observed, additional measures may be necessary, such as re-orienting or relocating the NuStep model T6. b. Over the frequency range 150 kHz to 80 MHz, field strengths should be less than 3 V/m.			

EMC Tables

Table 4 - Recommended separation distance between portable and mobile RF communications equipment and the NuStep® T6 Recumbent Cross Trainer

<p>The NuStep Recumbent Cross Trainer is intended for use in an electromagnetic environment in which radiated RF disturbances are controlled. The customer or the user of the NuStep T6 Recumbent Cross Trainer can help prevent electromagnetic interference by maintaining a minimum distance between portable and mobile RF communications equipment (transmitters) and the NuStep as recommended below, according to the maximum output power of the communications equipment.</p>			
Rated maximum output power of transmitter W	Separation distance according to frequency of transmitter		
	150 kHz to 80 MHz	80 MHz to 800 MHz	800 MHz to 2.5 GHz
	d = 1,2	d = 1,2	D = 2,3
0,01	0,12	0,12	0,23
0,1	0,38	0,38	0,73
1	1,2	1,2	2,3
10	3,8	3,8	7,3
100	12	12	23
<p>For transmitters rated at a maximum output power not listed above, the recommended separation distance d in metres (m) can be estimated using the equation applicable to the frequency of the transmitter, where P is the maximum output power rating of the transmitter in watts (W) according to the transmitter manufacturer.</p> <p>NOTE 1 At 80 MHz and 800 MHz, the separation distance for the higher frequency range applies.</p> <p>NOTE 2 These guidelines may not apply in all situations. Electromagnetic propagation is affected by absorption and reflection from structures, objects and people.</p>			

US FCC Compliance & IEC/EN 55011 Compliance

US FCC Compliance Statement:

Note: This equipment has been tested and found to comply with the limits for a Class B Digital Device, pursuant to Part 15 of the FCC Rules. These limits are designed to provide reasonable protection against harmful interference in a residential installation. This equipment generates, uses and can generate radio frequency energy and, if not installed and used in accordance with the installation instructions, may cause harmful interference to radio communications. However, there is no guarantee that interference may not occur in a particular installation. If the equipment causes harmful interference to radio or television reception, which can be determined by turning this equipment off and on, the user is encouraged to try and correct the interference by one or more of the following measures:

- Reorient or relocate the receiving antenna
- Increase the separation between the equipment and the receiver
- Connect the equipment into an outlet on a circuit that is different from that to which the receiver is connected
- Consult the dealer or an experienced radio/TV technician for help

IEC/EN 55011 Compliance Statement:

This device complies with IEC/EN 55011, Group 1, Class B. Group 1 contains all ISM equipment in which there is intentionally generated and/or used conductively coupled radio-frequency energy which is necessary for the internal functioning of the equipment itself. Class B equipment is suitable for use in domestic establishments and in establishments directly connected to the low voltage power supply network which supplies buildings used for domestic purposes.

European Authorized Representative



Note:

Any serious incident that has occurred in relation this product should be reported to NuStep, LLC, the above listed European Authorized Representative, and the EU competent authority of the member state in which the user is established. The expected service life of this product is ten years.

NuStep, LLC
5111 Venture Drive, Suite 1
Ann Arbor, MI 48108
U.S.A.
800-322-4434
734-769-4400
www.nustep.com



The information in this manual is the most current at the time of printing. Due to our commitment toward continuous improvement, specifications and descriptions are subject to change without notice. No part of this manual may be reproduced or transmitted in any form or by any means, electronic or mechanical, for any purpose without the express written permission of NuStep, LLC.

© Copyright April 2021 by NuStep, LLC.

NuStep® and Transforming Lives® are registered trademarks of NuStep, LLC.

ISO 9001:2015 Registered

Manual PN 52390 T6 User Manual, Rev Bp1